

H1825SW14A-2757V36-02H90

PRODUCT SPECIFICATION

Features:

- ◆ Excellent transiting heat from LED chip operating under 1200mA.
- ◆ Provide uniform cross distribution of positive white and warm white dual color scheme, mixed pure.
- ◆ High luminous output.
- ◆ No UV.
- ◆ Encapsulated materials are environmentally certified and meet environmental requirements.

Chip Material:

- ◆ GaInN

Emitting Color:

- ◆ White
- ◆ Warm white

Applications:

- ◆ Commercial lighting
- ◆ General Lighting

Part No.	H1825SW14A-2757V36-02H90	Spec No.	WKF-BF0324	Page	1 of 10
----------	--------------------------	----------	------------	------	---------

Package Dimensions:

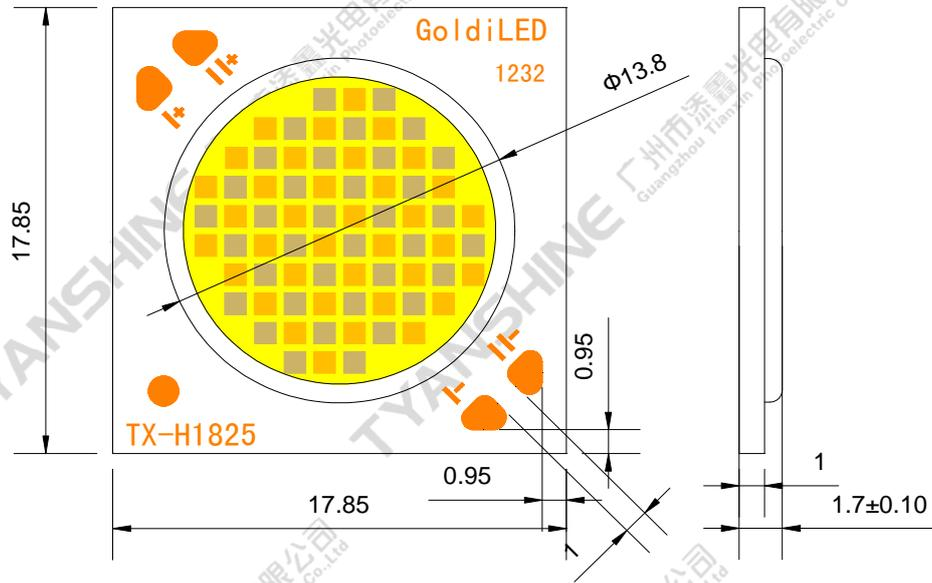

I: Warm white ; II: White

Notes:

- 1.All dimensions are in millimeters .
- 2.Tolerances unless otherwise mentioned are $\pm 0.25\text{mm}$.

Code Formats:

H1825SW14A-2757V36-02H90

H	18	25	SW	14	A	—	2757	V36	—	02	H90
high brightness	series	watt typ	performance	LES	texture	—	CCT	VOLTs	—	BOM	Ra

Absolute Maximum Ratings

Parameter	Symbol	Ratings	Unit
Forward Current	IF	1200	mA
Reverse Voltage	VR	Not designed for reverse operation	V
Power Dissipation	PD	W	W
		S	
Junction Temperature	Tj	W	°C
		S	
Case Temperature (C)	Tc	85	°C
Electrostatic Discharge Threshold (ESD)	ESD	2000	V
Storage Temperature	Tstg	-30~+100	°C
Operation Temperature	Topr	-30~+80	

Notes:

- Specifications are subject to change without notice.
- The data on this specification is for reference only and the actual data is in accordance with the acknowledgment.
- Precautions for ESD:
STATIC SHIELD Electricity and surge damages the LED. It is recommended to use a wrist band or anti-electrostatic glove when handling the LED. All devices, equipment and machinery must be properly grounded.

Electrical Optical Characteristics (Tc=25°C)

Parameter	Symbol	Condition	Emitting color	Min.	Typ.	Max.	Units
Luminous Flux	ϕ_v	If=750mA	S	—	2000	—	lm
			W	—	2750	—	
Forward Voltage	V_f		S	32	34	36	V
			W	32	34	36	
Correlated Colour Temperature	CCT		S	—	2800	—	K
			W	—	5800	—	
Viewing Angle at 50 % IV	$2\theta_{1/2}$		S	—	115	—	Deg
			W	—	115	—	
Reverse Current	I_R		—	—	—	—	μA
Thermal Resistance Junction to Case	$R\theta_{J-C}$		S	—	0.28	—	K/W
		W	—	0.28	—		
Temperature Coefficient of Voltage	$V\Delta F/T$	S	—	-13.2	—	mV/°C	
		W	—	-13.2	—		
Color Rendering Index	Ra	S	—	90	—	—	
		W	—	90	—		

Notes:

- Luminous intensity is measured with a light sensor and filter combination that approximates the CIE eye-response curve.
- $\theta_{1/2}$ is the off-axis angle at which the luminous intensity is half the axial luminous intensity.
- Luminous flux measurement tolerance: $\pm 15\%$.
- Forward voltage measurement tolerance: $\pm 0.15V$.

Typical Electrical/Optical Characteristics Curves

(25°C Ambient Temperature Unless Otherwise Noted)

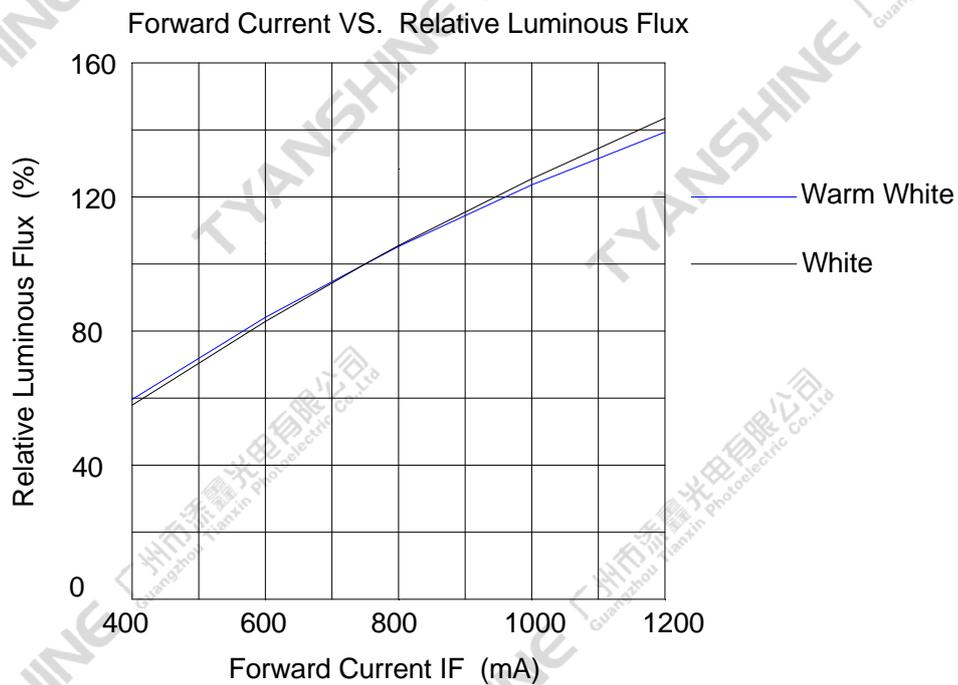
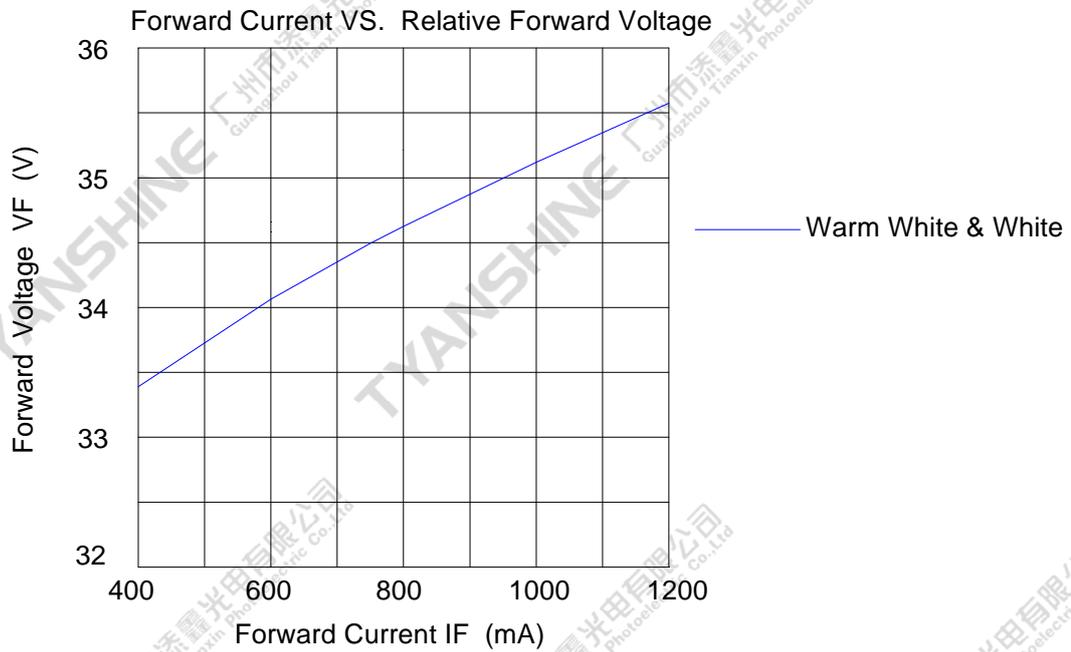

Temperature VS. Relative Luminous FLux (IF=750mA)

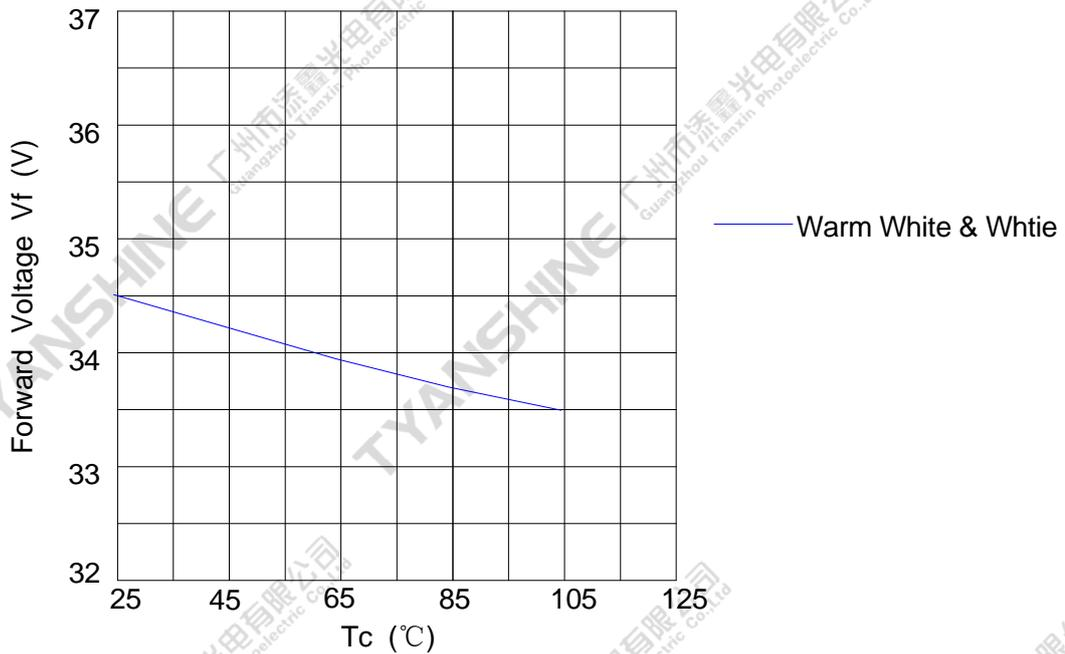

Temperature VS. Forward Voltage (IF=750mA)

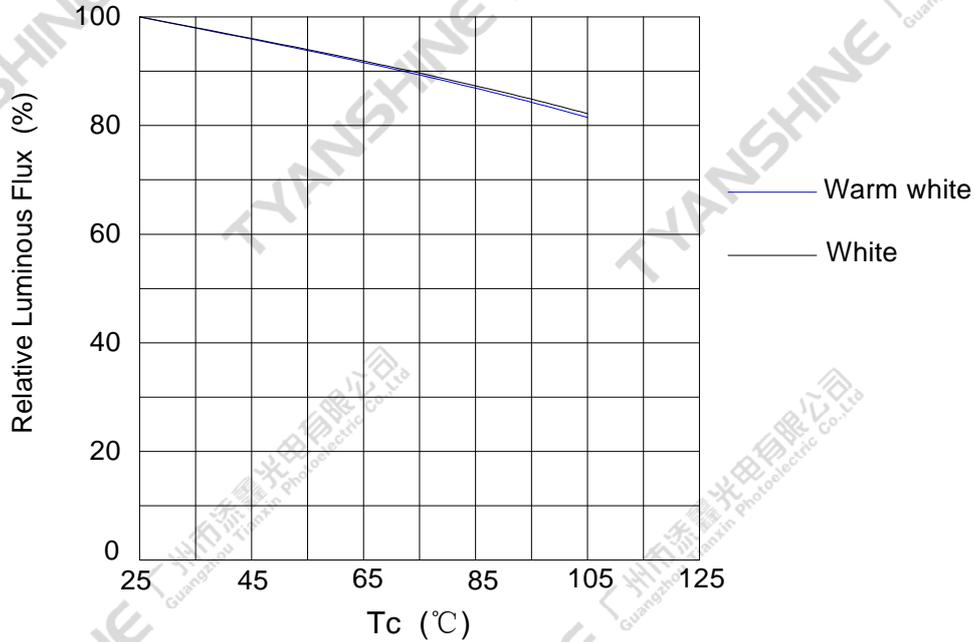

Relative Chromaticity VS. Current

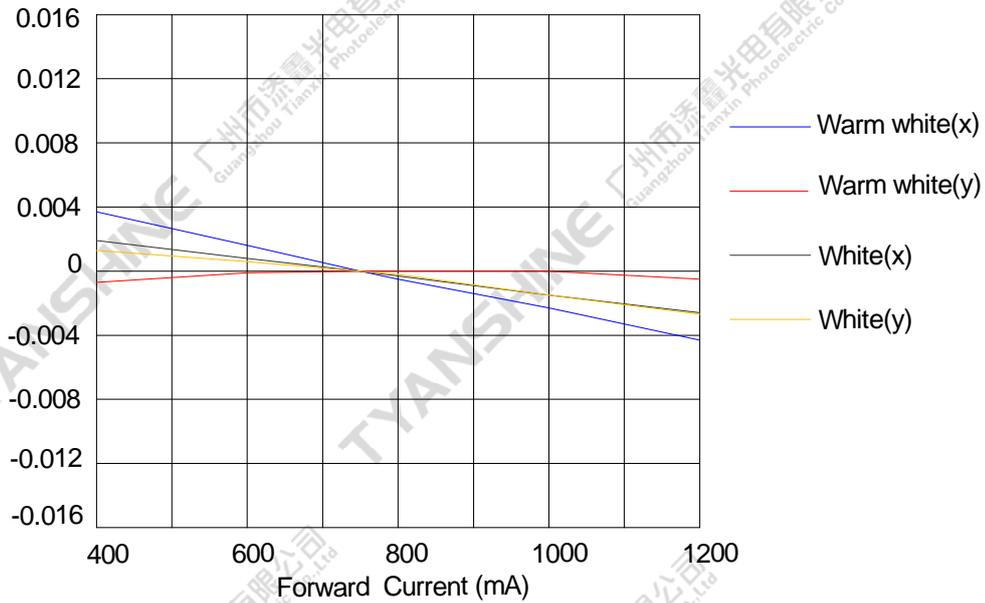

Relative Chromaticity VS. Temperature (IF=750mA)

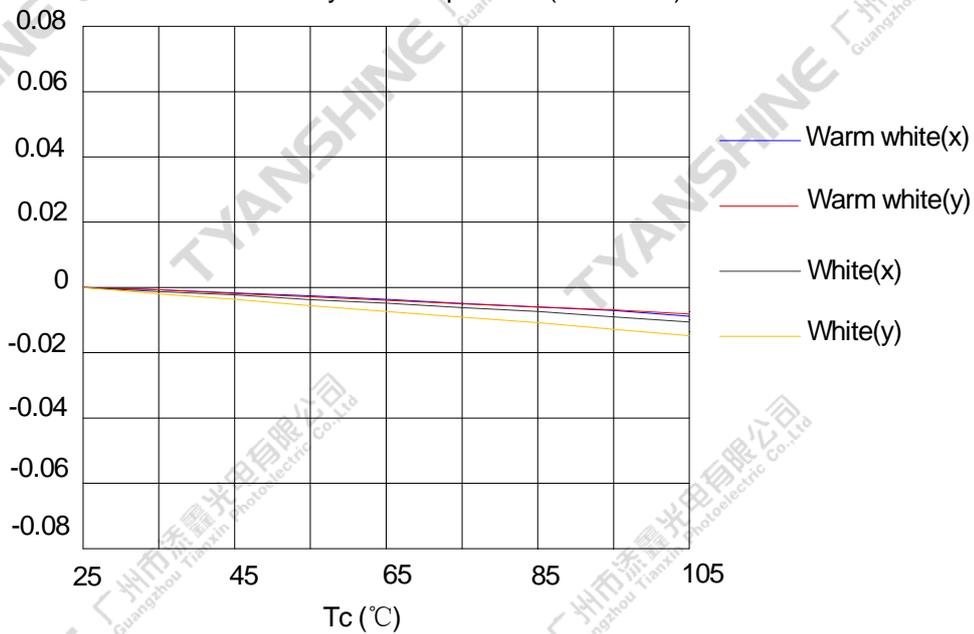

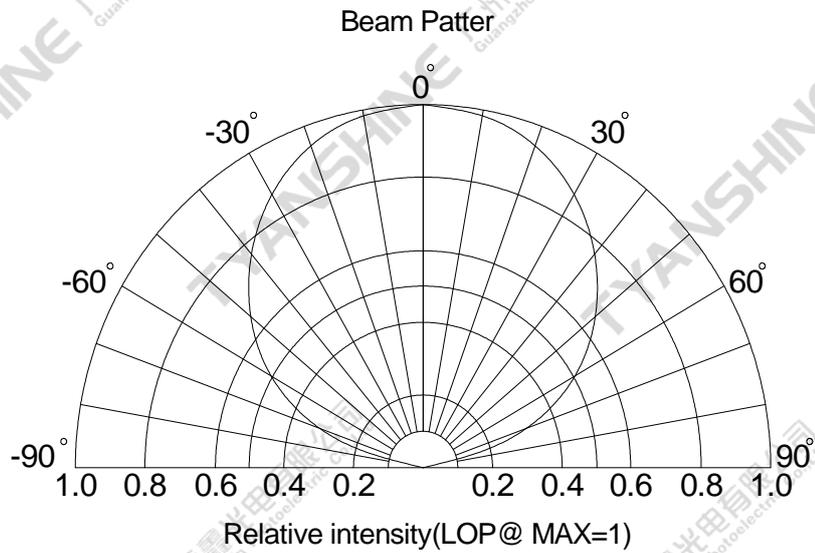
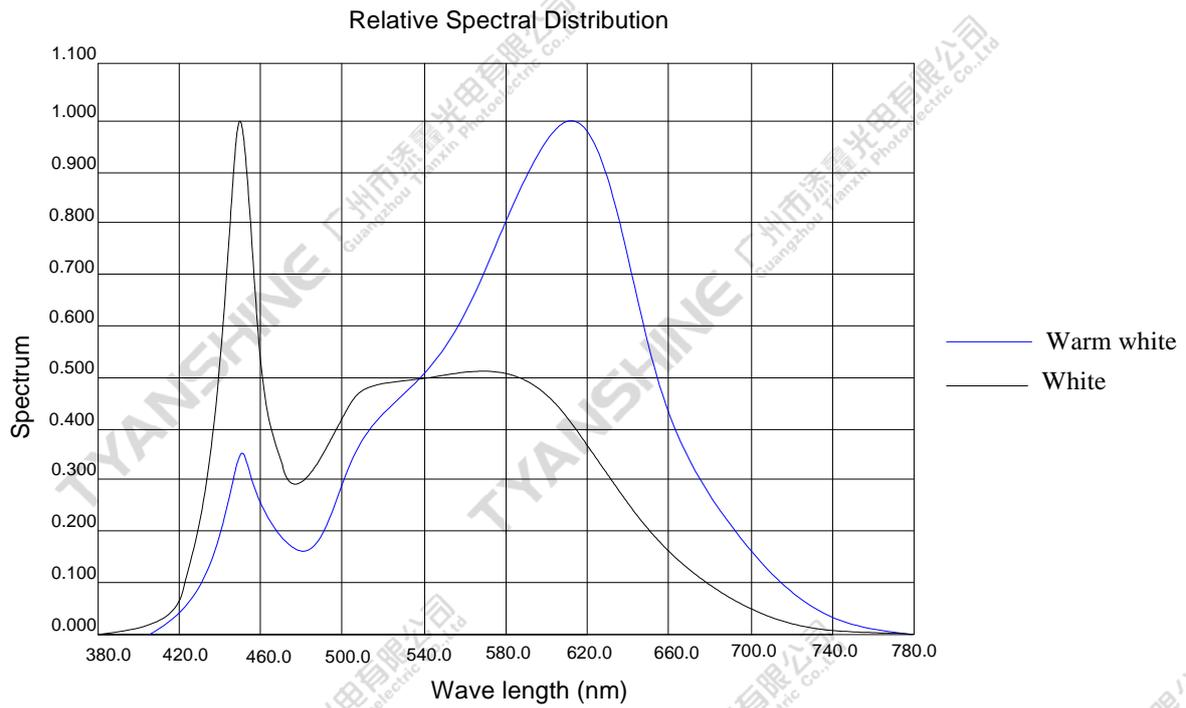

Notes:

1. $2\theta \frac{1}{2}$ is the off axis angle from lamp centerline where the luminous intensity is 1/2 of the peak value.
2. View angle tolerance is $\pm 5^\circ$.

Chromaticity Coordinates (Condition : IF=750mA , Tc=25°C)

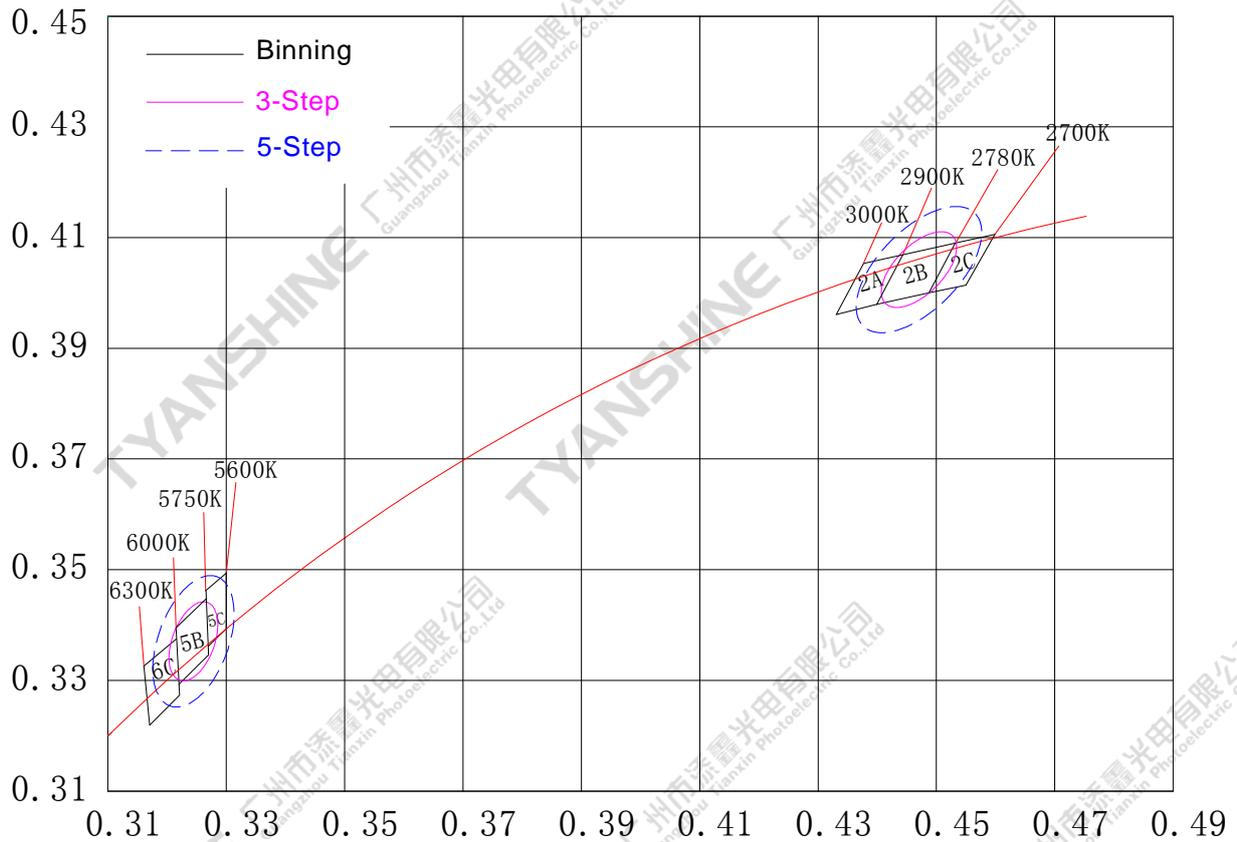

Reliability Test

Test Item	Test Condition
Continuous Operation Test	IF=750mA Ta=25°C ×1000hrs
Low Temperature Storage Test	-30°C × 1000 hours
High Temperature Storage Test	100 °C × 1000 hours
Moisture-proof Test	85 °C, 85 %RH for 500 hours
Thermal Shock Test	-30 °C × 30 minutes – 100 °C × 30 minutes, 100 cycle

Dimensions For Cannulation And Packaging

Quantity: 36PCS

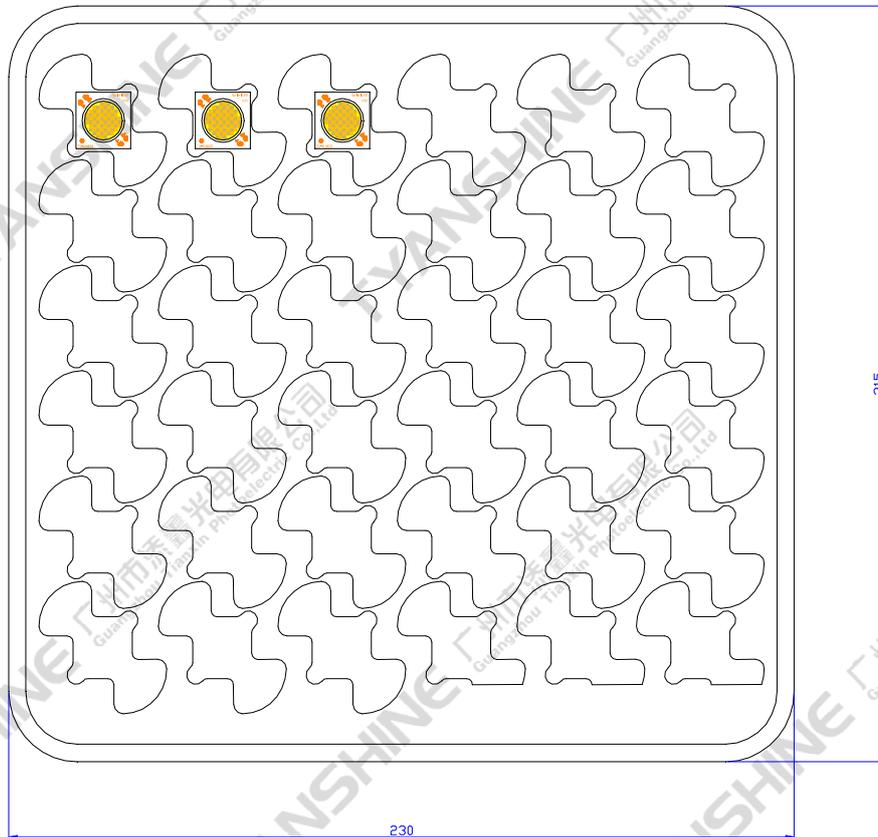

Notes:

1. All dimensions are in millimeters.
2. Tolerances are ± 2.0 mm unless otherwise noted.
3. The products are packaged together with silica gel, Transport, not to the weight of welding LED light-emitting area, As a result of the weight of LED light-emitting zone in the quality of, Irreponsible of the Company.

Part No.	H1825SW14A-2757V36-02H90	Spec No.	WKF-BF0324	Page	10 of 10
----------	--------------------------	----------	------------	------	----------